

ZIVA 6636

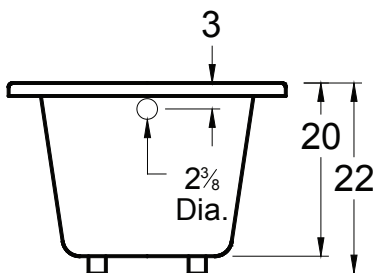
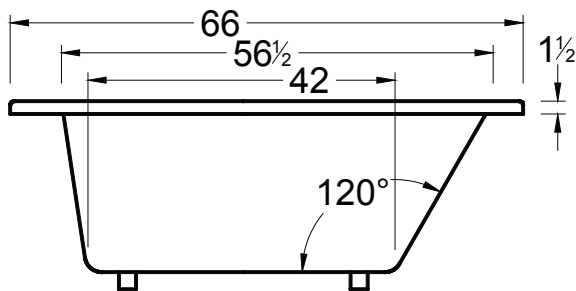
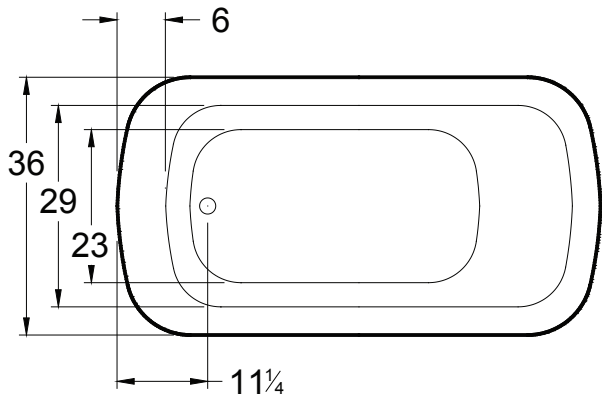

DIMENSIONS

66" x 36" x 22" (1676 x 914 x 559 mm)

Whirlpool Operating Gallons = 50 (Liters = 189)

Gallon to Overflow = 75 (Liters = 284)

MATERIAL

Acrylic

TUB FLOOR

Non - Textured

UNDERMOUNT: Yes

- Advise Americh when ordering to ensure there are no issues with deck mounted controls.
- Always take dimensions directly from the unit.

APPROVALS & COMPLIANCE



Americh products meet or exceed the following standards:

- Underwriters Laboratories (UL)
- Underwriters Laboratories - Canada (cUL)
- Canadian Standards Association - (CSA)
- ANSI Z124.1 • ANSI A112-19.7
- ANSI A112.19.8

Contact Americh for additional approvals.

STANDARD EQUIPMENT

- Adjustable Feet

BATHING SYSTEMS

LEGEND

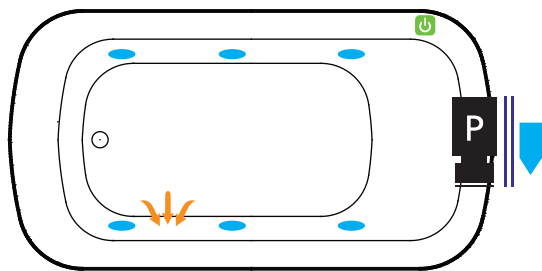

Builder Series

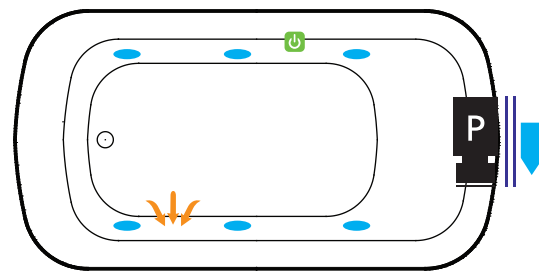

Luxury Series

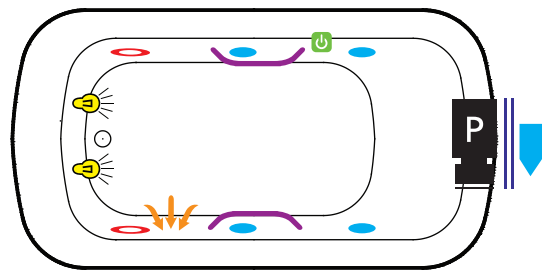

Platinum Series

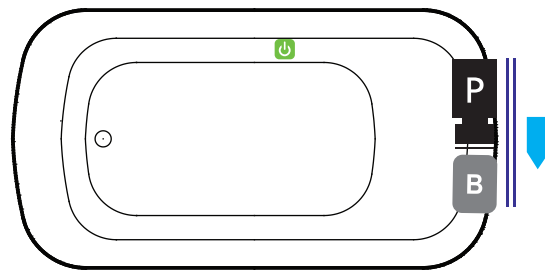

Combination
(pump and blower location only)

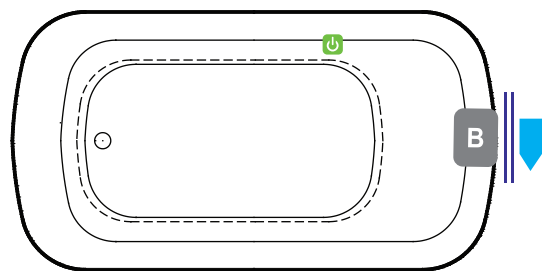

Airbath System II

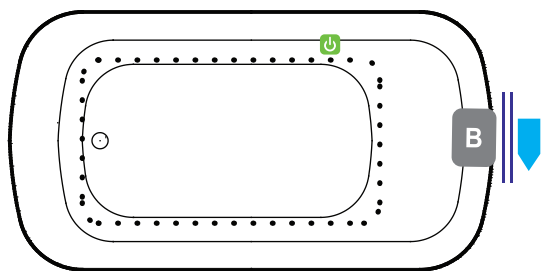

Airbath System V



Pump



Blower



Jet



Rotary Jet



Suction



Light



ON/OFF Control



Grab Bar



Access Panel
(Minimum 16" X 20")



Label

OPTIONAL ACCESSORIES

- ANEX (Americh Nanobubble Experience)
- Chromatherapy
- Grab Bars: 9" - 14" - 16"
- High Density Insulation
- iBath Sound System
- Inline Heater (whirlpool only)
- Jets: Additional or Rotary
- Ozone System (whirlpool and/or Airbath only)
- Pillows: 12" - Angle
- Remote Control Upgrade (select series only)
- Serenity Soak (tub only)
- Thermal Comfort System
(TCS cannot be used with VSM)
- Trim Kit Upgrade
- Vibro Sonic Massage
(VSM cannot be used with TCS)
- Waste & Overflows Upgrades
 - Cable Drive Waste & Overflow
 - PVC Waste & Overflow
 - Linear Waste & Overflow

INSTALLATION TIPS

- 1) Install according to Owner's Manual and local codes.
- 2) Any tub with whirlpool, Airbath® or ANEX system requires an access panel.
- 3) Hot water supply should be 65-75% of tub capacity or greater.
- 4) Cut Dimensions: 2" Smaller than Size of tub. It is recommended to wait for unit to arrive before cutting.
- 5) Always consult your local plumber for recommendations as installations will vary.
- 6) The combination of multiple systems and options may require components to stick out and/or be remotely installed in the field.
- 7) All specifications are subject to change without notice.
 - Certain options or altering the pump/blower location may cause the pump/blower to extend beyond the tub decking.
 - Factory installed aprons may increase the overall height of the tub when ordered with certain accessories (ie. Linear Drain).
- 8) Center Drain tubs with Linear Drain option may not use 9" Grab Bar option. Only the 14" or 16" Grab Bar option is available on these units.

ELECTRICAL REQUIREMENTS

Americh recommends one 20 amp ground fault circuit interrupter (GFCI) for each power supply provided with the bathtub.

(*) STANDARD ON PLATINUM SERIES

Last Update 08/25/20

Always check the website for the most updated specifications: Americh.com